

AMT-A0060 6 GHz to 18 GHz Broadband Low Noise Amplifier with 5W CW Limiter

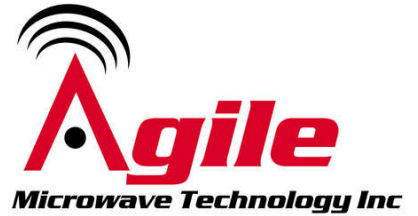

Data Sheet

Features

- 6 GHz to 18 GHz Frequency Range
- Typical Noise Figure < 2.5 dB
- Typical Gain 27 dB
- Gain Flatness < ± 1.5 dB typical
- 5W CW Input power survivability
- +12 dBm P1dB
- Internally Regulated
- Operates from a Single +8V Supply
- Unconditionally Stable



Applications

- Receiver front end,
- Communication systems
- Microwave Radio systems
- Test Equipment

Description

The AMT-A0060 is a Broadband Low Noise amplifier with Integrated 5W CW Limiter over the full frequency range. The performance is achieved through the use of AMT's proprietary technology. The amplifier I/Os are Internally matched to 50 Ohms and DC block. The AMT-A0060 is ideal for use as Front End of receiver system, or where amplification is required without adding excessive noise in a Hi-Rel communications system for Commercial or Military applications

Functional Diagram

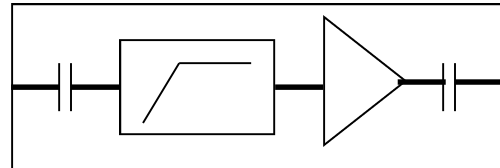

MAXIMUM RATINGS¹ EAR99

| Parameter | Symbol | Units | MIN | MAX |
|------------------------------|------------------|-------|-----|------|
| Operating Temperature – Case | T _{MO} | ° C | -40 | +85 |
| Storage Temperature - Case | T _{MS} | ° C | -40 | +150 |
| RF Input power (CW) | P _{in} | dBm | | +37 |
| Die T _{Junction} | T _J | ° C | | +150 |
| Positive Supply Voltage | V _{+SS} | V | | +15 |

1.Stresses above those listed under "Absolute Maximum Rating" may cause permanent damage to the device. This is a stress rating only and functional operation of the device at these or any other conditions above those indicated in the operational sections of this specification is not implied. Exposure to absolute maximum rating conditions for extended periods may affect device reliability.

Do Not Apply DC to RF ports

ELECTRICAL SPECIFICATIONS @ 23°C

| Parameter | Conditions | Units | MIN | Typical | MAX |
|--------------------------|---|-------|-----|---------|-------|
| Frequency Range | | GHz | 6 | | 18 |
| Gain | Small Signal | dB | 23 | 26 | |
| Gain Flatness | | dB | | ±1.5 | ±3 |
| Input Power | CW, without damage | dBm | +37 | | |
| Output Power (P1dB) | 1 dB compression point @ 12 GHz | dBm | 10 | 12 | |
| OIP3 | OIP3 measured @ 12 GHz Two tone F1-F2=10MHz | dB | | 20 | |
| Noise Figure | | dB | | 2.5 | 2.9 |
| RF Input Impedance | Reference to 50 ohms VSWR | | | 1.8:1 | 2.2:1 |
| RF Output Impedance | Reference to 50 ohms | | | 1:8:1 | 2.2:1 |
| Supply Voltage Positive: | | V | | +8 | |
| Supply Current Positive: | | mA | | 65 | 100 |

Notes:

1/ Unconditional Stability

Customized configurations of the above specifications are available

Typical Performance @ 23°C

S- Parameters

CH1 LOG 10 dB/ REF 0 dB
S11 5: -13.935 dB 18.000 000 000 GHz

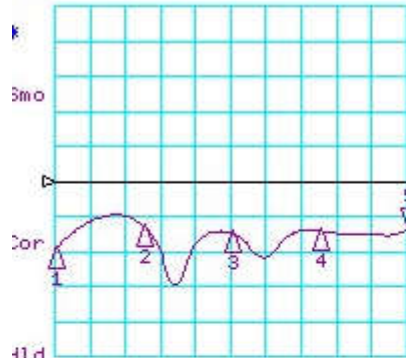

CH1 Markers
1: -19.077 dB
6.00000 GHz
2: -12.438 dB
9.00000 GHz
3: -14.646 dB
12.00000 GHz
4: -14.106 dB
15.00000 GHz

START 6000.000 MHz STOP 18000.000 MHz

CH3 LOG 10 dB/ REF -10 dB
S12 5: -45.613 dB 18.000 000 000 GHz

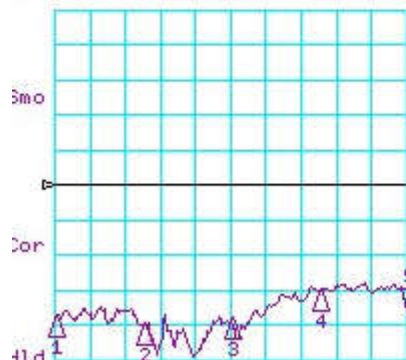

CH3 Markers
1: -47.426 dB
6.00000 GHz
2: -49.609 dB
9.00000 GHz
3: -48.396 dB
12.00000 GHz
4: -39.900 dB
15.00000 GHz

START 6000.000 MHz STOP 18000.000 MHz

CH2 LOG 10 dB/ REF 0 dB
S21 5: 23.395 dB 18.000 000 000 GHz

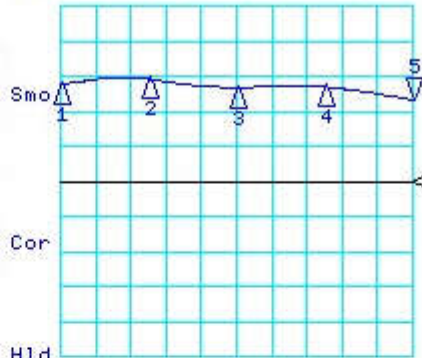

CH2 Markers
1: 27.764 dB
6.00000 GHz
2: 29.234 dB
9.00000 GHz
3: 26.851 dB
12.00000 GHz
4: 27.051 dB
15.00000 GHz

START 6000.000 MHz STOP 18000.000 MHz

CH4 LOG 10 dB/ REF 0 dB
S22 5: -13.973 dB 18.000 000 000 GHz

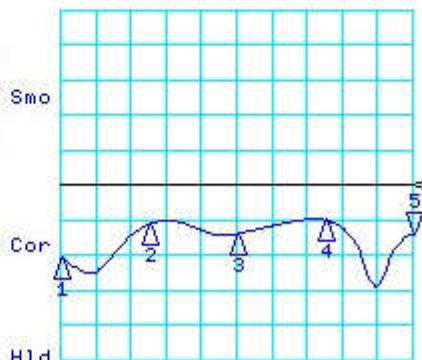

CH4 Markers
1: -20.900 dB
6.00000 GHz
2: -11.229 dB
9.00000 GHz
3: -13.844 dB
12.00000 GHz
4: -9.8550 dB
15.00000 GHz

START 6000.000 MHz STOP 18000.000 MHz

Package Outline: M088 SMA Connectorized mm(inches)

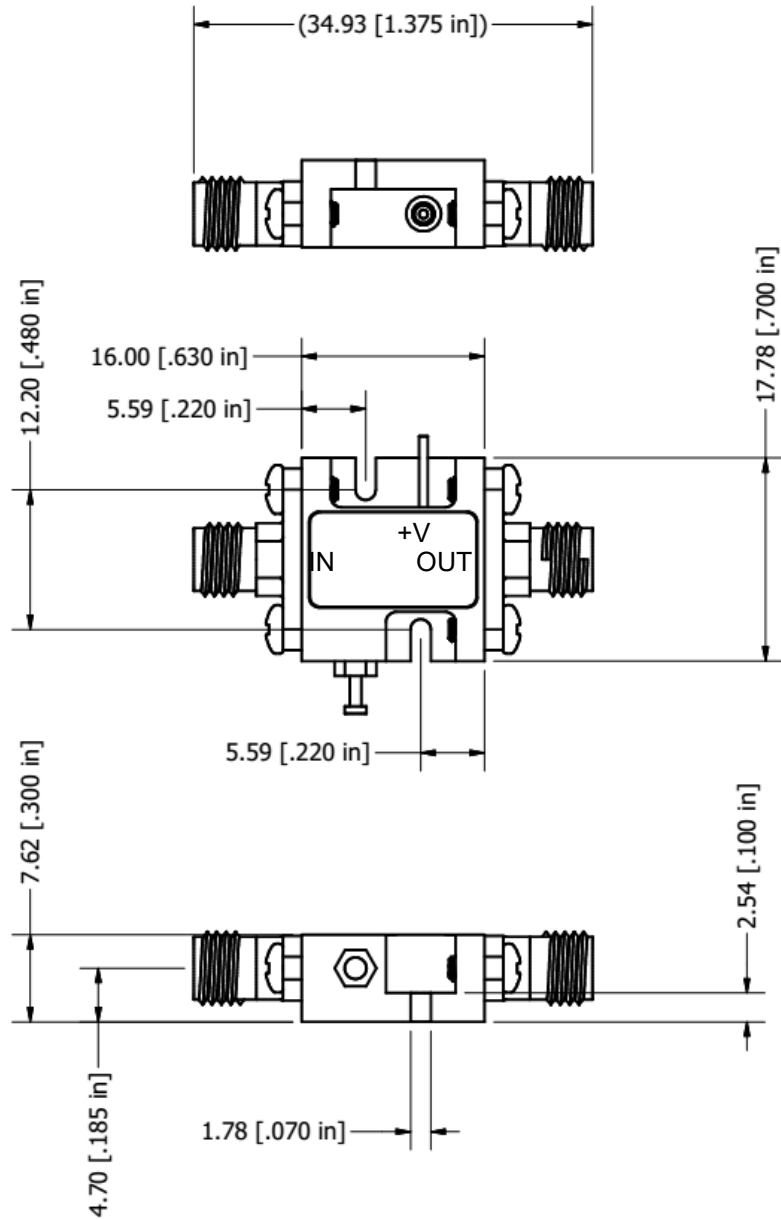

Note: Field replaceable SMA connectors
Removable Ground Slug

| Model Number | Description | Hermeticity | Package |
|--------------|-------------|--------------|---------------|
| AMT-A0060 | SMA Female | Non-Hermetic | Outline: M088 |

Contact us for custom configurations and special requirements.

Our highly experienced team of engineers can quickly identify and implement innovative solutions using latest technology to improve performance and reduce cost.

- Add additional functionality: Input limiter, Temperature compensation, Amplitude/Phase matching, Amplitude/Phase Tracking, Automatic Gain control, Gain sloping, Bypass path, Specific supply voltage, Regulation, Power detector, Health status, and others
- Integrated: Filters, Switches, Limiter, Digital attenuator, Phase shifter, Microcontroller, Multiple amplifiers, Switch matrix, Comb generators and others
- Mechanical: Custom packages - Surface Mount, Connectorized, Waveguide, Carrier, Drop-in, Hermetic and others

Agile Microwave Technology Inc is the logical choice for all your commercial or military RF/Microwave components/module requirements.

Contact Information:

**701 Cascade Pointe Lane
Cary, NC 27513**

**ISO 9001:2015
Certified Company**

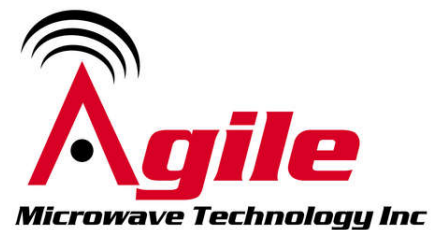

Phone: (984) 228-8001

info@agilemwt.com

www.agilemwt.com

AMTI reserves the right to change at any time without notice the design, specifications, function/form or availability of its products described herein. The buyer/customer has the responsibility to validate the performance for their applications. No liability is assumed as result of use of this product and no patent licenses are implied. AMTI reserves all rights.